

**PSF 8v8
OFFICIAL RULEBOOK & OFFICIATING
MANUAL**



2025

TABLE OF CONTENTS

INTRODUCTION	PAGE 2
MISSION STATEMENT	PAGE 2
PHILOSOPHY & GOALS	PAGE 2
ORGANIZATION/TEAM STRUCTURE	PAGE 3
COACHES CERTIFICATION	PAGE 3
PLAYER CERTIFICATION	PAGE 5
ROSTER	PAGE 6
COACHES	PAGE 6
ROSTER SIZE	PAGE 6
DIVISION AND AGES	PAGE 7
ADD/DROP	PAGE 7
MINIMUM GAME REQUIREMENTS	PAGE 8
GAME OPERATIONS	PAGE 8
BALL SIZES	PAGE 8
COIN TOSS	PAGE 9
CHAIN CREW	PAGE 9
GAME CLOCK/TIMEOUTS	PAGE 9
SPECIAL TEAMS	PAGE 10
SCORING	PAGE 10
MERCY RULE	PAGE 11
OVERTIME	PAGE 11
PLAYOFF OVERTIME	PAGE 12
PLAYOFF SEEDING	PAGE 12
EQUIPMENT	PAGE 12
ADDITIONAL EQUIPMENT	PAGE 13
CELEBRATIONS	PAGE 13
CONDUCT	PAGE 13
PLAYER CONDUCT	PAGE 14
COACHES CONDUCT	PAGE 14
SPECTATORS CONDUCT	PAGE 15
SUSPENSIONS	PAGE 16
SECURITY	PAGE 16
INCLEMENT WEATHER	PAGE 16
GENERAL FORMATIONS & RULES	PAGE 16
ADMISSIONS	PAGE 23
PAYMENT PROCESS	PAGE 23
GENERAL KNOWLEDGE	PAGE 24

INTRODUCTION

Premier Spring Football League, LLC (referred to as PSF), is dedicated to the children who participate in PSF and to their safety and enjoyment. The rules for PSF activity of any type as published in this book are to be followed scrupulously. Failure to enforce these rules can result in legal action, dismissal and/or loss of membership. Each family and each adult volunteer in the program must be covered by excess medical and liability insurance of some type. Although participation in PSF is statistically safe, such insurance should include coverage for “participant risk.” All programs/teams must have minimum insurance limits of \$100,000 Medical, \$1,000,000 General Liability, and \$1,000,000 Sexual Abuse/Molestation to participate. All PSF activities are open to both boys and girls, including “mixed” teams. However, for the sake of convenience, these rules refer to participants as if of the male gender only.

All games are to be played under PSF rules. The rules contained herein ARE REQUIRED to be enforced by PSF and organizations/teams. Failure to do so will result in penalties and/or fines as defined herein, in the PSF rulebook.

NO RULES WILL BE ADDED AFTER FEBRUARY 1st UNLESS REQUIRED FOR SAFETY REASON(S).

For all purposes, the PSF playing season shall be defined as January 1st through May 31st or the last game/competition, whichever comes first. All organizations/teams, administrative personnel, coaches, players, and cheer participants are subject to disciplinary action for violations of PSF rules and regulations occurring at any time during a stated playing season.

MISSION STATEMENT

Our mission at Premier Spring Football League is to become the “PREMIER” Spring Football League, by improving the academic, social, and athletic success rate of student-athletes in all our programs. PSF requires all organizations to instill a solid foundation for all STUDENT-ATHLETES through SCHOLARSHIP, LEADERSHIP, ACCOUNTABILITY, INTEGRITY, AND TEAMWORK. PSF aims to enrich the lives of all youth by educating them in cultural diversity, character development, community involvement and self-worth.

PHILOSOPHY AND GOALS

PSF is a program operated for the benefit of its youth participants. The program’s philosophy has been academics and athletics go hand-in-hand. At every level, PSF seeks to develop well-rounded young men and women who learn not only the fundamentals of football, cheerleading and dance, but also the importance of education, in an atmosphere conducive to developing sound mind, body, and character - and having an enjoyable time along the way! The objectives of PSF are to inspire youth, regardless of race, creed, religion, or national origin, to practice the ideals of sportsmanship, scholarship, and physical fitness. PSF strives to make the game fun for all boys and girls. The program stresses learning lessons of value far beyond the playing or spirit days of the children involved, such as: self- discipline, teamwork, determination, friendship, leadership, and good sportsmanship. With such goals in mind, and by providing an opportunity to participate in an

organized, supervised environment with emphasis on maximum safety and participation, PSF offers young men and women a unique and memorable opportunity to excel.

ORGANIZATION/TEAM STRUCTURE

- All league & association administrators must be at least 21 years of age.
- A team is the universal, basic unit of an association. At a minimum, a team consists of a group of participants organized under the direction of a coaching staff in each age division.
- There are five (5) age classifications: 6U, 8U, 10U, 12U, 14U. These are the basic ages for competition in PSF.
- Associations will be placed into two levels of competition, hereafter known as Division 1 (D1) or Division 2 (D2) by PSF each year.
- PSF is a competitive league. Like all competitive leagues, recruitment of student-athletes is allowed. There are NO BOUNDARIES in recruitment; however, one should respect all programs serving youth.

COACHES CERTIFICATION

VOLUNTEER APPLICATION/WAIVER/PHOTO

- As a condition of service to a PSF league, all coaches, board of directors' members and any other persons or volunteer workers who have repetitive access to or contact with players and/or spirit participants, must complete and submit an official "Premier Spring Football Volunteer Application" to their local organization/team.
- The Volunteer Application must include signed permission from the applicant allowing the organization/team to perform the necessary background check. The official "Premier Spring Football Volunteer Application" shall only be modified to comply with local, state, provincial or national laws.
- All volunteers in PSF must sign an infectious disease waiver so that they understand the risks.
- A current photo of the volunteer is required. PSF will require a new photo every season.

BACKGROUND CHECK

- Annual background checks must be completed prior to the applicant assuming his/ her duties for the current season and should be submitted to PSF prior to the start of the current season. Refusal to submit a fully completed "Premier Spring Football Volunteer Application" annually must result in the immediate dismissal of the individual or denial of participation for the applicant.
- No organization/team shall permit any person to participate in any manner whose background check reveals a conviction for, or guilty plea to, any crime involving or against a minor. In addition, other charges and convictions may be an indication of an unfit volunteer, and therefore an association may prohibit any individual from

participating as a volunteer if the association deems the individual unfit to work with minors, as long as the association applies the same criteria uniformly for all individuals seeking to volunteer.

- Each organization/team shall also require an administrator to be responsible for enforcing that each member of an organization/team has completed and submitted a volunteer application and background check. An administrator from every organization/team MUST sign an Association Confirmation of Compliance document, which states all organization/team members have completed volunteer application and background check. All volunteer applications and association affidavits must be maintained by PSF for a period of a minimum of 1 year.
- All associations must conduct a nationwide search that contains the applicable government sex offender registry data such as the Lexis Nexis online National Criminal database search, or a government agency sponsored state search of criminal records. Additionally, if a League utilizes only a state sex offender registry check, that association must also perform a national database or a federal background check search.
- If a local association becomes aware of information, by any means whatsoever, that an individual, including, but not limited to, volunteers, players and hired workers, has been convicted of or pled guilty to any crime involving or against a minor, the organization/team must immediately contact the applicable government agency to confirm the accuracy of the information. Upon confirmation of a conviction for, or guilty plea to, a crime against or involving a minor, the association must prohibit the individual from participating in any manner.
- PSF has no direct operational control over the selection of volunteers, each association shall be required to indemnify and hold harmless PSF against all legal actions based upon allegations arising from a failure to enforce all or part of this regulation. Failure to comply with all or part of this regulation may result in the suspension or revocation of the organization/team.

NOTE: Individuals who coached in the previous fall season do not have to complete a background check if they have a badge from their fall league. This badge needs to be uploaded into League Magic, in background check location.

ONLINE CERTIFICATION

- Complete and score greater than 80% on the online test, via Youth Sports Knowledge online at: <https://youthsportsknowledge.com/default.asp>
- Upload complete certification into League Magic in designated location.
- Cost will be \$25

COACHES BADGES

Once all requirements and documents are completed and uploaded by registered coaches and volunteers, PSF administration staff will print and distribute volunteer badges to all organizations/teams prior to kickoff classic.

- All teams will have a **MAXIMUM** of 6 badges. Included in these 6 badges head coach, assistant coaches, junior coaches and team mom(s).
- Only 1 waterboy/ball boy are allowed to be on the sideline. This individual will not need a badge and **MUST** be between the ages of 5-15.

NOTE: A deadline will be communicated to all organizations/teams for documents to be completed and uploaded. This is to ensure all volunteers receive their badges, if the deadline is not met this may cause a delay in individual badges being distributed.

PLAYER CERTIFICATION

Certification is that process whereby the team or association will file with the league, which it is a member.

A candidate cannot begin practice with a team until he/she has officially registered. Registration consists of completing and submitting all the following items in this section in addition to any/all local required forms. The sign-up fee, if any, may be collected at this time. All candidates must furnish the following to be registered and before starting practice:

- **PHOTO**-A current photo of the participant is required. PSF will require a new photo every season. The player's face with some of the shoulders must be taken in the photograph.
- **PARENTAL CONSENT** -The Participant Contract and Parental Waiver/Medical Release form needs to be completed by either parent or the legal guardian, stating that the child has his or her permission to compete.
- **MEDICAL EXAMINATION** - A signed and/or stamped form from a licensed state medical practitioner valid through May 15th of the upcoming season; (i.e., medical doctor, registered physician assistant, registered nurse practitioner, etc.) that the candidate is physically fit and there are no observable conditions which would prevent playing football or cheer.

NOTE: If a regular school medical examination was performed and the results are releasable to parents, a copy of such a report may be used in lieu of a new examination.

SPECIAL NOTE: A person with a loss of limb may participate provided that the individual has a signed statement of approval from an examining physician and that the use of the artificial limb is no more dangerous to players than the corresponding human limb and does not place an opponent at a disadvantage.

- **PROOF OF AGE** - An original birth certificate on file bearing the seal of the issuing office of the state of birth is the best guarantee of reliability of claimed date of birth and is the form of proof most recommended. Passports are also reliable. Military ID and/or State ID cards are acceptable. PSF does not mandate retaining the originals once participants have completed certification process.
- **INFECTIOUS DISEASE WAIVER** - Infectious disease waiver (volunteer and participants): All participants in PSF must sign waiver that they understand the risks.

ROSTER

A roster consists of coaches, team parent and players. A roster is certified once the PSF certification process is completed.

COACHING STAFF

- A head coach will direct and determine the assignments of the assistant coaches, and together the coaching staff is in complete charge of the team whenever it is together on the practice or playing field, traveling as a group to and from practice sessions and games. It is required that each head coach have their own copy of the current year's rulebook. All coaches are to be selected by methods approved by the organization/team and PSF rules (mandatory background check, complete and pass online training etc.). As it relates to PSF certified badge holders, a coach is automatically terminated at the close of each season and must start the registration process annually.
- The head coach must be 21 years or older to supervise all practices, games, and functions. However, an assistant coach must be at least 18 years of age and a coach-trainee must be at least 16 years of age, maximum 17 years of age, and if under the age of 18 must include a parent consent form to be approved and receive a badge.
- A football team may have any combination of certified coaches and team parent(s), not to exceed six (6) total.

ROSTER SIZE

There is no minimum or maximum number of players that a coach can have on a team. However, a team must start the game with a minimum of 6 players. The game shall be forfeited in the event a team does not fill the minimum numbers of players at the start of the game.

***NOTE:** The referee has the authority to stop/call the game if they deemed the game to be unsafe, due to a team not having enough players to compete.

- **MINIMUM ROSTER SIZE** - A minimum of 8 players must be dressed and eligible to play in each game. A team which fails to dress the minimum number of players shall forfeit the game. Any team which forfeits two successive games by reason of an insufficient number of players shall be investigated by the PSF for determination as to

whether to forfeit the balance of the season. The forfeiture fee is \$250 per division. (FINE IS DUE WITHIN 72 HOURS TO PSF).

NOTE: PSF strongly recommends teams maintain 12-15 players.

- MAXIMUM ROSTER SIZE – PSF would recommend teams not exceed more than 25 players to allow all kids play time. However, PSF does not have a maximum roster size.

DIVISION AND AGES

Teams are placed into either division 1 (D1) or division 2 (D2) by the PSF staff. This will be completed prior to the playoffs. PSF will complete intensive research to ensure all teams are competing in the correct division. All placement of teams is at the discretion of the PSF staff.

- Every organization/team shall assign participants to the appropriate age division, which is determined by age.
- Teams will be placed into two levels of competition, known as Division 1 (D1) or Division 2 (D2) determined by PSF each year.
- PSF has five (5) age classifications: 6U, 8U, 10U, 12U, & 14U.
- League Age is based on the player's age as of July 31st of the year preceding the playing of the tournament. (i.e., if the tournament is being played in 2025 then the player's age is based on July 31st, 2024)
- The Premier Spring Football League (PSF) is an unlimited weight program.

NOTE: Where possible PSF will schedule games based on age, therefore a D1 team may play a D2 team in the regular season.

NOTE: Once certified for a division, or team a participant shall not be permitted to recertify to another division or team during the current season under any circumstances.

NOTE: Players may play in their designated divisions or up ONE division from their age group only. (i.e., a 10-year-old may play on the 10U or 12U teams)

***This is not recommended by PSF staff, this is at the discretion of the parent and/or organization.**

ADD /DROP DATE

- A team may add participants to its certified roster up to the hard-cutoff date established by the conference. No participants can be added after Week 2 of the season. Rosters will be locked the Sunday after the second game.

MINIMUM GAME REQUIREMENTS

- A participant **MUST** have participated or checked in for a minimum of 4 regular season games to be eligible to participate in playoffs.

NOTE: Kick-off classic games count towards the 4 minimum games needed.

GAME DAY OPERATIONS

DIGITAL BOOK CHECK PROCEDURES

PSF field generals will complete the digital check-ins for both teams as it relates to players and allowable sideline personnel. This process will be done prior to the beginning of all contests and should be done by the end zone within 5 minutes prior to the beginning of the game. If a player is late to a contest, that players coach may call a timeout to certify those players that are late **ONLY IN THE FIRST HALF**. These players can also be checked in at half time as well. **THERE SHALL BE NO LATE CHECK-INS** after the second half of the play has begun.

OFFICIALS FIELD REQUIREMENTS

The playing field will be forty yards wide and eighty yards long, with two ten-yard end zones.

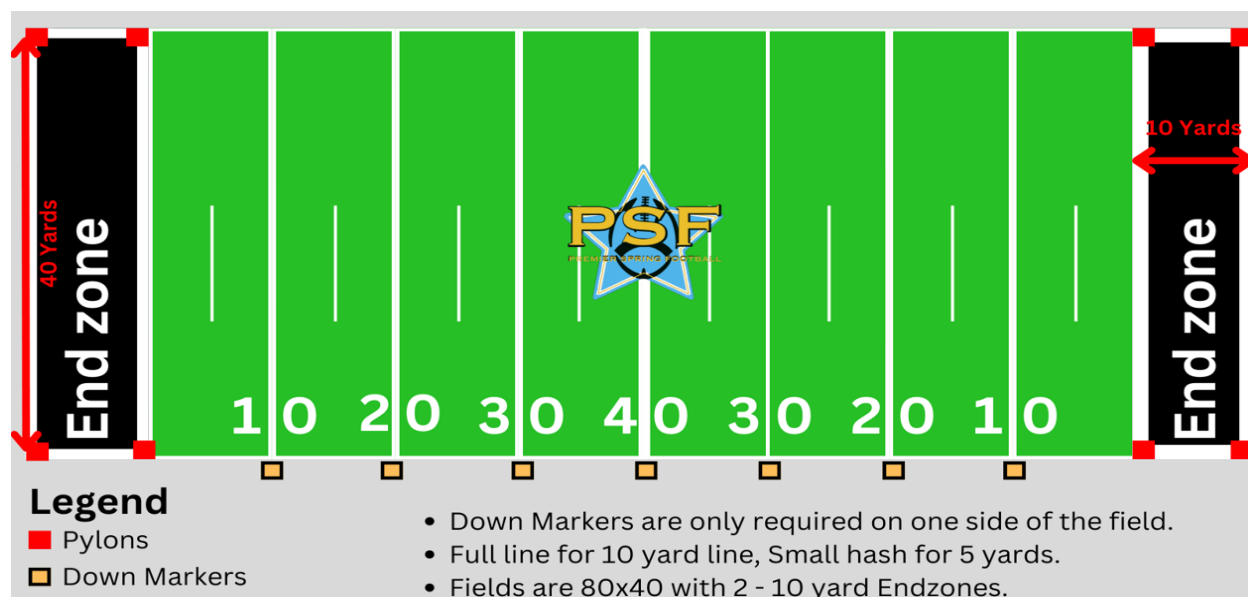

GAME BALLS

The ball shall be of a good grade of leather or composite material. The game ball must be comparative to a Wilson Traditional Youth Football with specifications like the following (rubber balls are prohibited):

<u>LEVEL</u>	<u>SIZE</u>
6U & 8U	K2
10U & 12U	TDJ
14U	TDY, TDS or high school equivalent

All balls must be approved by the game official prior to the start of the game. Composite footballs

are allowed. Each team will be required to provide their own football, taking into consideration the grade, level, and size. The use of ANY application on the football to enhance the players performance is prohibited.

COIN TOSS

The PSF coin toss is done in the middle of the field prior to the start of the game. The coaches and/or the captains of the teams should be present. The referee will select an individual from either team to call either heads or tails in the air as the coin flips. The referee can elect to either catch it in the air or allow the coin to land on the ground. At this point heads or tails will be determined.

- The team that wins the toss can elect to be on offense or defense
- The team that loses the coin toss can determine the direction of start of play.

NOTE: After halftime, the teams will switch the start of the game roles. The team that was on defense is starting the 2nd half on offense. Play will start in the opposite direction than 1st half.

CHAIN CREW

The chain crew is the responsibility of the home team, based on the PSF schedule. If the game is delayed due to lack of chain crew a 5-yard delay of game penalty will be access to the home team. After the event of 3 consecutive delay of game penalties, the game will result in a forfeit for the home team, regardless of score.

NOTE: To avoid a forfeit the coaching staff may hold the chains, but if this occurs those individuals are not allowed to coach their team while holding the chains.

NOTE: Chains should be held on the home team's sideline.

GAME CLOCK/TIMEOUTS

PSF game clock consists of four 10-minute quarters of a running clock and a 5-minute halftime break. The time will be kept on the field with constant communication between the white hat and the line judges to ensure both coaching staff are aware of the time. At the end of each quarter the referees will change the direction of play, allowing a quick water break until play is resumed.

CLOCK STOPPAGE TIMES ARE:

- The last 2 minutes of the end of game and will revert to normal high school game clock.
- During the "two-minute warning" called by the referee, this will serve as a "quick" timeout for both teams
- During referee and team timeouts
- During injuries

NOTE: If a referee deems a player was coached to fake an injury to stop the clock, there will be a 15-yard unsportsmanlike conduct on the head coach and player.

READY FOR PLAY

The offense is given twenty-five seconds from the referees “ready for play” signal to snap the ball. Failure to do so will result in a delay of the game penalty.

TIMEOUTS

Each team will be allowed 2 30-second timeouts per half. This is a “USE IT OR LOSE IT” concept, timeouts do not carry over to the next half. Referees will determine water breaks; however, they are not mandatory, due to the fact of them being granted at the end of the quarter while the field direction changes. Water breaks are solely at the discretion of the officials.

SPECIAL TEAMS

The PSF 8v8 format does not have special team events such as: kick-offs, punts, field goals, and kicking of an extra point.

NO KICK-OFFS

There are no kick-offs. The start of play will be from the 20-yard line at the beginning of the game and after any scoring event, where the ball is deemed a change of possession.

NO PUNTS

There are no punts. The referee will ask the offensive team if they are going for the 4th down or “declare” to punt. Once the official knows the offensive teams’ intentions the official will communicate to the defensive team. In the case of the offense declaring a punt, there will be a 25-yard walk-off from line of scrimmage. During the last 2 minutes of the game after the third down ends the officials will place the ball and signal the fourth down ready for play. The offensive team must declare their intentions to punt or go for the 4th down, within the normal play clock.

NOTE: If a punt is “declared,” the team will be granted a 25-yard walk off and a 10-second run off the game clock; with the exception that no punt shall exceed the 20-yard line of the opposing team.

Example: If you are on the 30-yard line and “declare” to punt, the result of your punt will be only 10 yards, because the result of the punt cannot exceed the 20-yard line.

SCORING

PSF scoring is as follows:

Touchdown6 points
Safety2 points

NOTE: After a safety, the ball is placed at midfield (40-yard line) with a new series awarded to the team that scored the safety.

Extra points

6U & 8U Divisions **from the 3-yard line**

Point after TD by pass.....2 points
Point after TD by run1 point

Extra points

10U or higher Divisions **from the 3-yard line**
 Point after TD by run or pass1 point
 10U or higher Divisions **from the 5-yard line**
 Point after TD by run or pass2 points

MERCY RULE

PSF implemented a Mercy Rule which is incorporated for the safety of the participants and to incorporate sportsmanship.

Anytime a team goes up by 24 points or more, the following will occur:

- The official clock will become a running clock (even inside 2-minutes of the end of game) and once started can only be stopped for injury of a player or at the discretion of a referee.
- Should the point difference come within one (1) possession, which is 8 points or less; at that time ONLY, will the clock revert and be operated in normal fashion.

NOTE: There are NO LIMITATIONS of what plays offensive team may run and NO LIMITATIONS of defensive schemes, during the “MERCY RULE” period.

Example: Offensive team may pass and/or run. They are not limited to running between the tackles and not passing. They are allowed to run their normal offense. Defensive team can run their normal schemes. They are allowed to blitz, press receivers, and run defensive line twist; they can operate with NO LIMITATIONS.

NOTE: The game will be called if a team is up by 35 or more points.

OVERTIME

A tie game at the end of regulation play shall use Premier Spring Football overtime system is as follows (with the understanding of rotating possessions):

- Place the ball at the 25-yard line (1st & 10 rule applies) and each team gets one possession. If the defense gets an interception or recovers a fumble it results in a turnover of downs.

*If the game is tied after the first overtime, the below will occur (with the understanding of rotating possessions):

- Place the ball at the 25-yard line (1st & 10 rule applies) and each team gets one possession. If the defense gets an interception or recovers a fumble it results in a turnover of downs.
- Each team **MUST go for a 2-point conversion**, according to the division format below:

Extra points

6U & 8U Divisions **from the 3-yard line**
 Point after TD by pass.....2 points
 Point after TD by run1 point

Extra points

10U or higher Divisions **from the 3-yard line**
 Point after TD by run or pass1 point
 10U or higher Divisions **from the 5-yard line**
 Point after TD by run or pass2 points

NOTE: Each team shall have only 1 time out per overtime possession.
NOTE: In the regular season there will only be 2 overtime sessions, if still tied the game will be recorded as a tie.

PLAYOFF OVERTIME

The playoff overtime is the same as regular season overtime, with the exception play continues until a winner is determined.
 In the case of the regular season overtime format ends in a tie after the second overtime. The following will occur until a winner is determined.

*If the game is tied after the second overtime, the below will occur **PENETRATION SESSION** of overtime (with the understanding of rotating possessions):

- Place the ball at the 25-yard line (NO FIRST DOWNS) and each team gets one possession.
- The deepest penetration **AFTER** 4 downs (results of a penalty apply)
- If a score occurs, the team can decide if they want to attempt a 1-point conversion or a 2-point conversion.

EXAMPLE: If Team A scores and goes for 1-point conversion, then Team B scores they can elect to go for a 2-point conversion to win the game.

NOTE: Penetration rule does not apply on unsuccessful extra points attempts.
NOTE: In the penetration session of overtime, if a team scores in 2 downs, the opposing team **MUST** score in 2 downs or the overtime session is over.

***This format will repeat until a winner is determined.**

PLAYOFF SEEDING

PSF has created a unique playoff seeding system, which is a combination of the human “eye test” and computer module, which takes the following inputs into consideration when ranking:

- Strength of schedule
- Common opponents
- Eye test from ranking committee
- Points allowed
- Point differential
- Victories and/or losses at any given point in the schedule
- Team knowledge (health of players)

EQUIPMENT

The list of proper equipment mandatory to participate in PSF is listed below:

- Helmet with facemask and proper fastening chinstrap
- Mouthpiece (must be visible to referee, but does not have to connect to helmet)
- Shoulder pads
- Hip pads and butt pad
- Thigh pads
- Knee pads must be worn over the knee and under the pants
- Cleats-Must be rubber or plastic. Cleats may not exceed a 1/2” in length.
ABSOLUTELY NO METAL CLEATS

Failure to have any of the above required equipment during a game shall subject the participant to be removed until such time as the required equipment has been repaired, replaced, added, or removed. The use of any altered equipment shall result in player disqualification if in a game.

ADDITIONAL EQUIPMENT

PSF also believes in player “SWAG,” so PSF allows additional items listed below:

- Gloves
- Visors are allowed, regardless of tinting, but must fall within the following guidelines: Athletically approved, non-shattering material, and ONLY attached with zip ties to allow for quick removal without removing helmet, should medical attention be needed for participant.
- Sleeves
- Cleat covers
- Armbands
- Backflaps

CELEBRATIONS

PSF allows players to express themselves for making a great play if it is not directed or taunting another player or team. Players may celebrate in the following manners:

- Raising his hand as he is running in for a score
- High stepping
- Dancing in the endzone
- Somersaulting into the endzone
- Flipping after scoring
- Celebrating with teammates after a touchdown or big play

NOTE: Anything directed at another player is deemed taunting and will receive an unsportsmanlike penalty.

NOTE: The celebrations are limited to ONLY the players that were on the field during the scoring play.

CONDUCT

To uphold the goals of PSF and ensure that all participants have the benefit of a safe and fun learning environment, all parents, guardians and other adults and attendees of PSF events, must behave accordingly and in a respectful, courteous, and sportsmanlike manner all the time. This will be enforced by PSF staff, game officials as well as security personnel at events.

PLAYERS CONDUCT

A player who receives two un-sportsmanlike conduct violations will result in an immediate dismissal of the violator and a fifteen-yard penalty. The referee and PSF site director have the authority to dismiss a violator after one unsportsmanlike conduct violation based on severity. The game will resume once the violator has left the field of play. Players ejected from a game will be required to miss the next game.

COACHES CONDUCT

All PSF volunteers will abide by a Code of Conduct which includes the following provisions. If any of these rules are broken, PSF shall have the authority to impose a penalty including permanent removal from the program. Members shall:

- Not smoke and/or use smokeless tobacco on the field.
- Not criticize players/spirit participants in front of spectators, but reserve constructive criticism for later, in private, or in the presence of team members if others might benefit.
- Accept decisions of the game officials and judges on the field and in competitions as being fair and called to the best ability of said officials.
- Not criticize an opposing team, its players, spirit participants, coaches, or fans by word of mouth or by gesture.
- Emphasize that good athletes strive to be good students and that both are physically and mentally alert.
- Strive to make every football and spirit activity serve as a training ground for life, and a basis for good mental and physical health.
- Emphasize that winning is the result of good teamwork.
- Not engage in excessive sideline coaching and shall not leave the bench area to shout instructions from the sidelines.
- Together with team officials, be jointly responsible for the conduct and control of team fans and spectators. Any fan who becomes a nuisance and out of control will be asked to leave or will be removed by authorities.
- Not use abusive or profane language at any time.
- Not “pile it on;” not encourages their team to get a commanding lead and raise the score as

high as it can. In these instances, every effort shall be made to let all players play.

- Not recommend or distribute any medication, controlled or over the counter, except as specifically prescribed by participant's physician.
- Not permit an ineligible player or spirit participant to participate in a game.
- Not deliberately incite unsportsmanlike conduct.
- Not possess or drink alcoholic beverages and/or use illegal substance on either the game or practice fields.
- Remove from a game or practice any participant when even slightly in doubt about his/her health, until competent medical advice is available.
- Be responsible for and always control their fans.
- Uphold all rules and regulations regarding Premier Spring Football League.
- Refrain from engaging in any action within or outside PSF which reflects negatively upon, or causes embarrassment to, the PSF brand.

SPECTATORS CONDUCT

- Any adult who is using alcohol, tobacco, or non-prescription drugs and/or appears intoxicated at a PSF event, and/or who is flagrantly rude, attempts to intimidate, verbally abuse, heckles, taunts, ridicules, boos, throws objects and/or uses vulgarity or profane language/gestures with an official, coach, volunteer, staff member, participant, or other event attendee, will be removed from the PSF event. The member association may issue a written warning to the individual regarding the misbehavior and the adult's children may also be removed from the event. Any adult who commits one or more of the above stated offenses a second time will be banned from all PSF events for the remaining of the season. Upon the second offense, their children may also be removed from the program(s) for that period. Furthermore, violators will be prosecuted by law enforcement, to the fullest extent possible.
- Any adult who physically or verbally assaults an official, coach, volunteer, staff member or participant or threatens grave bodily harm may be banned from all PSF events for the remainder of the season. In the event this happens, the individual children may also be removed from all PSF events for that same period. After the ban has expired, if the individual commits another offense of the adult code of conduct, the individual will be permanently banned from all PSF events and the individual's children may also be permanently removed from all PSF. Furthermore, violators will be prosecuted by law enforcement, to the fullest extent possible.
- Weapons are prohibited by all participants, parents, guardians, other adults, and attendees of PSF events, including but not limited to league practices and games, competitions, and

banquets. Anyone found in violation of this rule will be permanently banned from all PSF events, including but not limited to association practices and games, competitions, and banquets. Furthermore, violators will be prosecuted by law enforcement, to the fullest extent possible.

SUSPENSIONS

Any players or coaches who are ejected from a game will be required to miss the next game. **NO EXCEPTIONS!!!** If a player or coach is found participating in the next contest PSF reserves the right to forfeit any games in which the player and/or coach participating in. PSF also reserves eliminate the entire team from playoffs.

SECURITY

PSF mission is to provide a safe and family environment where all the participants and spectators feel safe and protected. The PSF staff will be providing armed security at all locations. Any incidents will be reported to authorities and PSF will provide any information to authorities.

INCLEMENT WEATHER

The following system will be used when game days are affected by weather delays:

- After three (3) consecutive 30-minute weather delays during a game - total 1.5 hours (90 minutes) delay, the games shall be stopped, and the day of events called due to inclement weather and deemed NC (no contest) for all games that never kicked off due to this stoppage.

NOTE: If the game was stopped in the 2nd half of game, the game score will be recorded as final

GENERAL FOOTBALL FORMATIONS & RULES

Normal play shall require eight (8) players on the field. A game is played between two teams consisting of eight (8) players each. A forfeit will result when the minimum is not met, which is six (6) players. Should the opposing team decide to play the game instead of taking the forfeit win, the game results shall be recorded and stand as a regular played game. When a team has the minimum number of players, which is six (6); they must line up in legal formations, which require five (5) players on the line of scrimmage.

NOTE: The opposing teams **DOES NOT** have to reduce to the minimum number of players on the field.

EXAMPLES OF LEGAL FORMATIONS

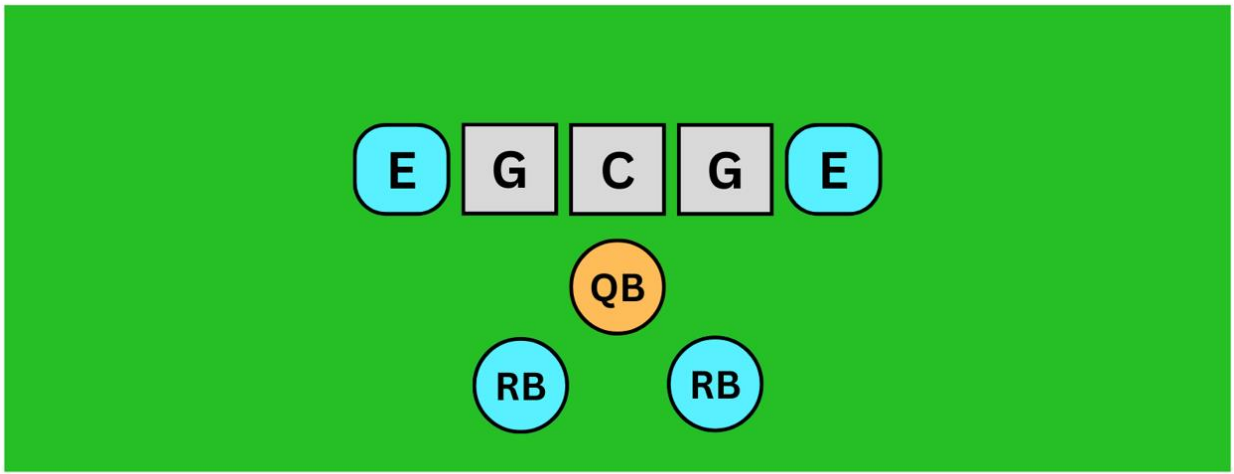

Legend

□ Eligible Receivers

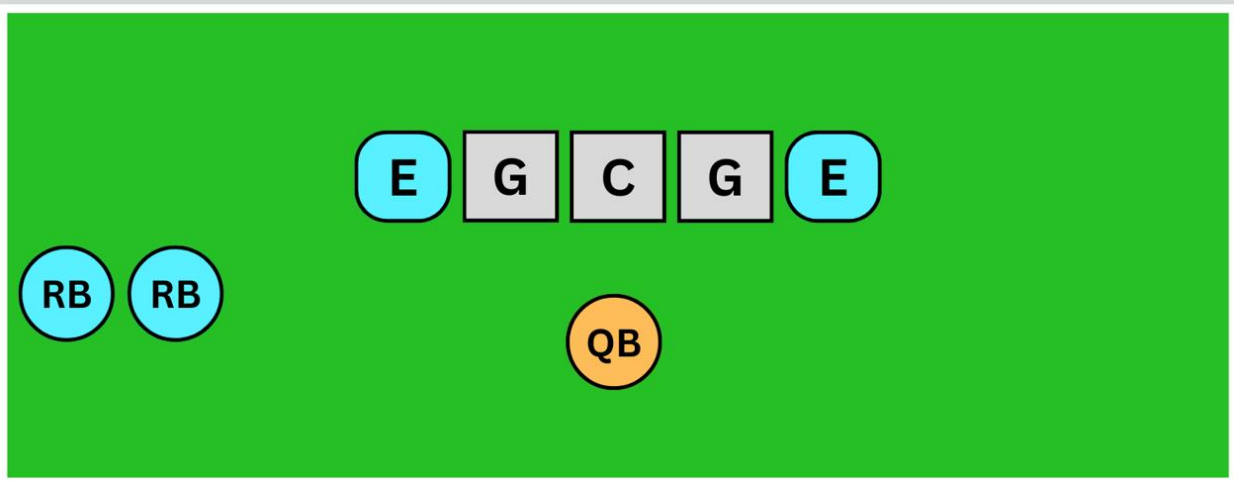

Legend

□ Eligible Receivers

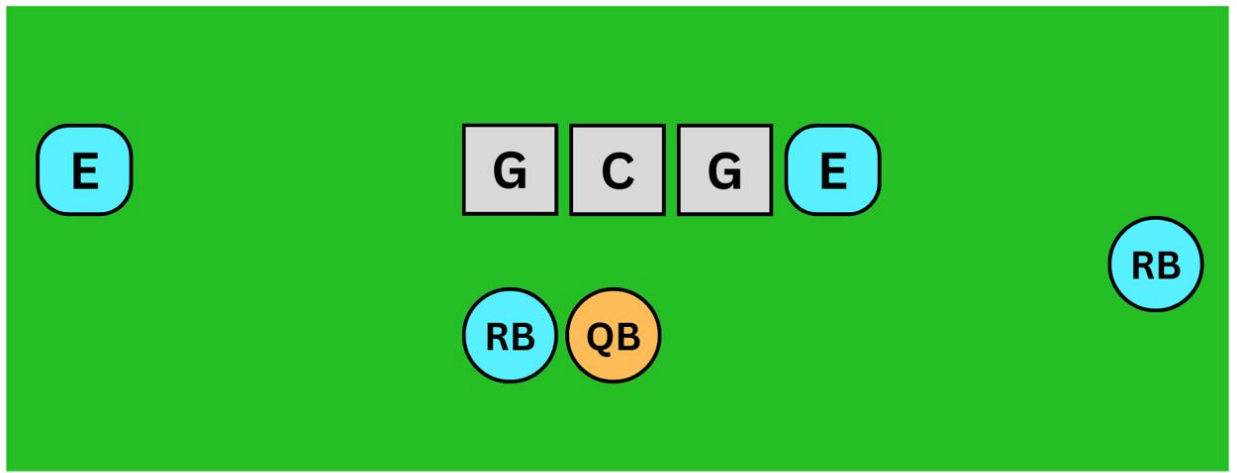

Legend

□ Eligible Receivers

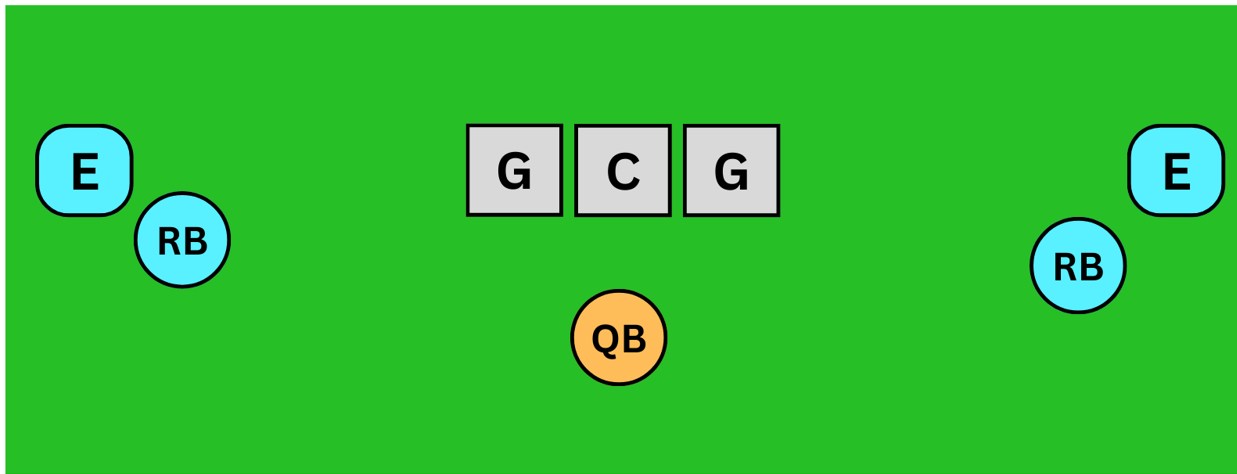

Legend

□ Eligible Receivers

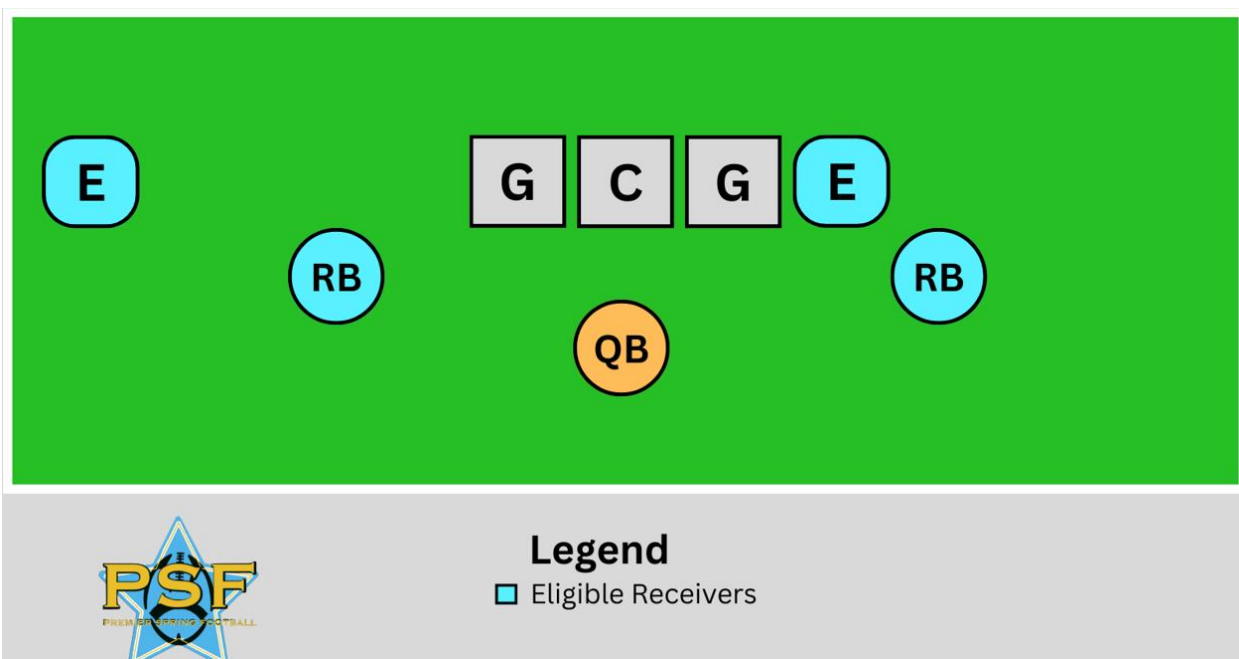

SPECIAL RULES BY AGE

6U Division

- One coach from each team shall be allowed on the playing field. Defensive coach just like the offensive coach may move players around prior to the snap of ball until the game official states **COACHES OUT!** The Offensive coach must move behind the white cap official/referee prior to snap of ball/defensive coach must move back 5 yards from deepest defensive player at the time the game official states **COACHES OUT!**

NOTE: Both coaches must remain a minimum of five (5) yards from the closest player to either team. Additionally, once the game official states **COACHES OUT**, no more offensive, or defensive instruction or player adjustments can be made by the coaches on the field! Should a coach break any part of this rule, it will be considered and penalized as unsportsmanlike conduct.

- A team will have 30 seconds to put the ball in play after the ready signal.
- Coaches **MAY NOT** escort players down the field while the ball is in play. Coaches who are on the field **CAN NOT** shout football instructions to the players after the ball is in play. Should a coach break any part of this rule, it will be considered and penalized as unsportsmanlike conduct.
- The linebackers must be a minimum of two (2) yards off the line of scrimmage and are not allowed to stunt. Once the ball is snap, they can blitz from his linebacker position.
- **ABSOLUTELY NO “CUT BLOCKING” ON THIS LEVEL**

- Once the QB/Center exchange (Exchange classified as QB being DIRECTLY under the Center) is secured, fumbles are allowed on this level. When QB is directly under center and snap is muffed, it will be considered a dead ball and moves to next down.

NOTE: If QB is lined up in Shotgun/Pistol the ball will be considered live from the time the center snaps. Therefore, should the QB muff snap, it will be considered a loose ball and live.

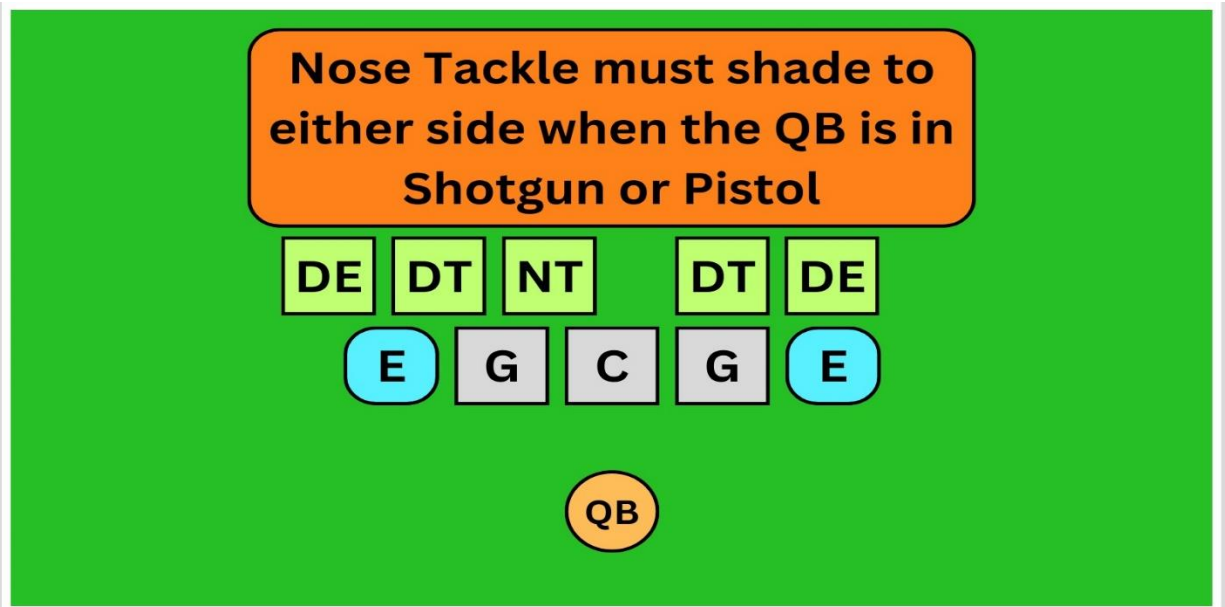

- For protection of the center, double "A" gap is not allowed.

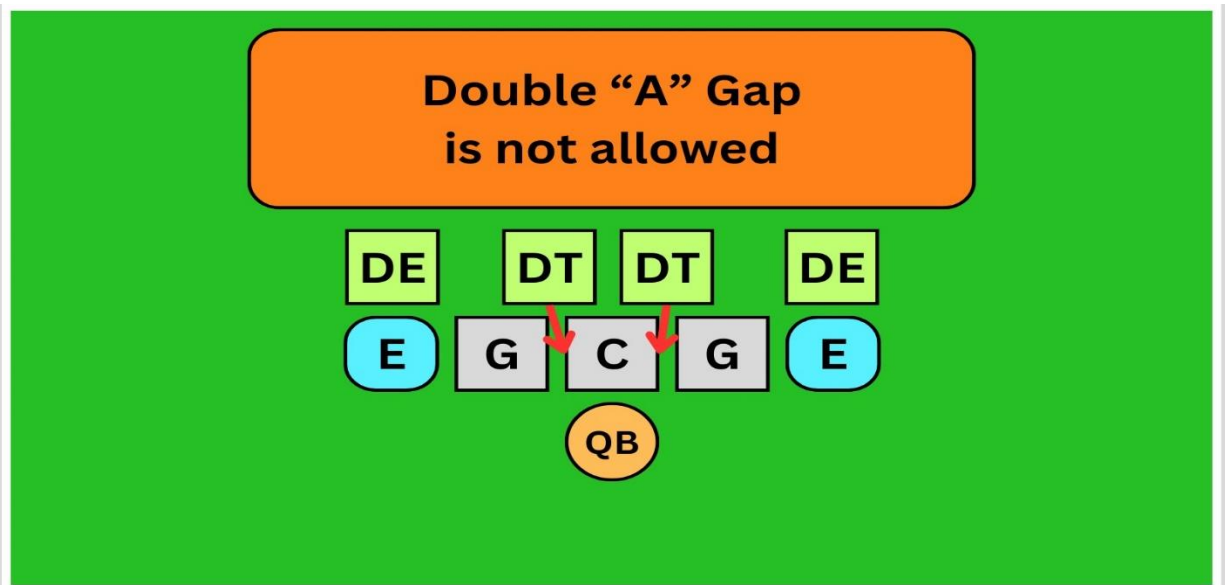

8U Division

- No coaches shall be allowed on the field except for timeouts and injured players.
- A nose tackle can line up directly over the center, as long as the QB is under the center. If QB is in a shotgun, the nose tackle **CAN NOT** lineup directly over the center.

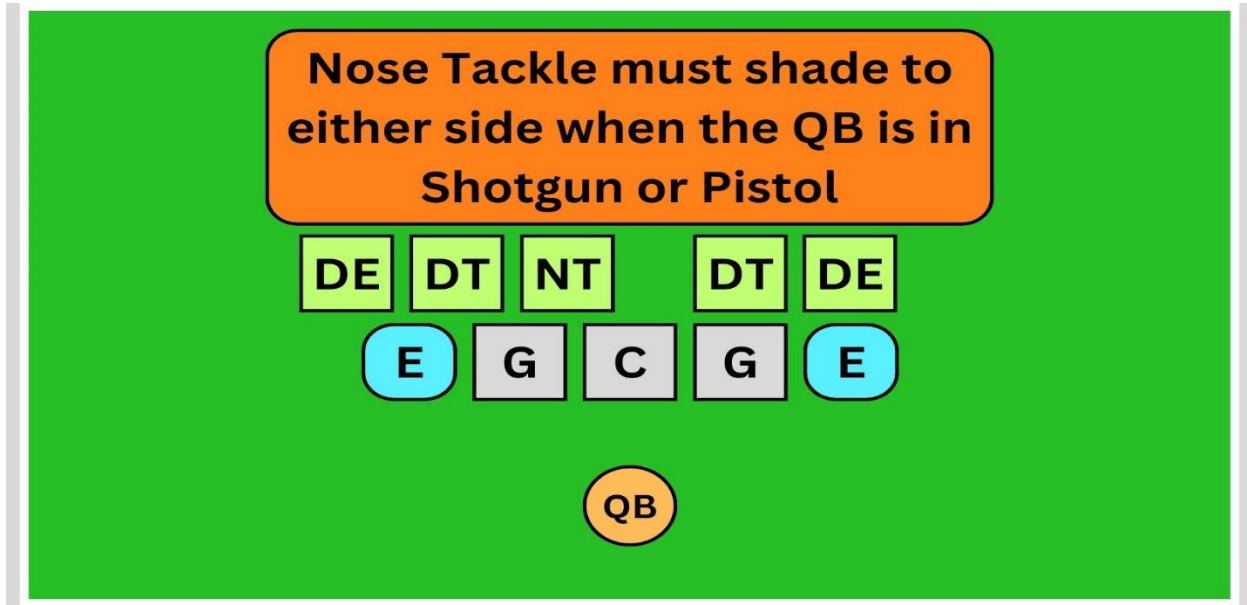

- **ABSOLUTELY NO “CUT BLOCKING” ON THIS LEVEL**
- A team will have 30 seconds to put the ball in play after the ready signal.

10U+ Divisions

The playing rules for 10U+ Divisions are all the same and in the absence of a PSF rule, NFHS rules (<https://www.nfhs.org/activities-sports/football/>) will apply.

- A team will have 25 seconds to put the ball in play after the ready signal.
- Blocking below the waist is allowed inside the designated “free blocking” zone. The “free blocking” zone is a rectangular area extending laterally 4 yards either side of the spot of the snap and 3 yards behind each line of scrimmage.

Example: Free Blocking Zone

Free Blocking Zone

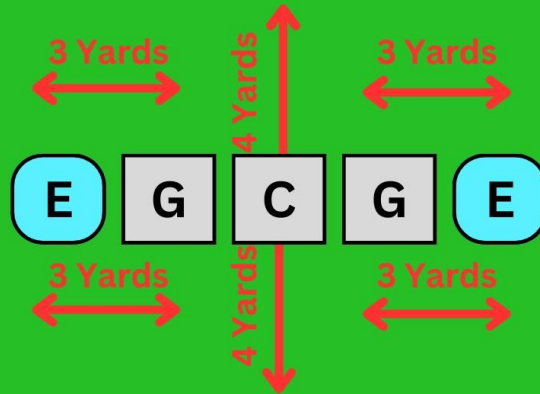

- On shotgun and/or pistol snaps, the defense **CAN NOT** line up directly over the center.

Nose Tackle must shade to either side when the QB is in Shotgun or Pistol

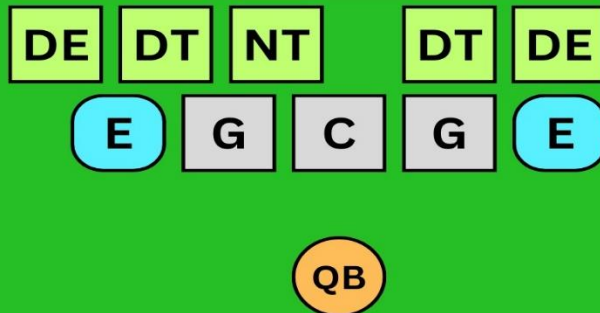

ADMISSIONS

PSF admission fees are \$10/adults and \$5/child (5-17yrs old) for regular season games. However, admission fees shall not be borne by any active rostered individual who is partaking in the event, including all pertinent PSF badge holders and Referees; all of whom shall be admitted free of charge with proper credentials.

***KICK-OFF CLASSIC PRICES ARE SUBJECT TO CHANGE**

***PLAY-OFF PRICES ARE SUBJECT TO CHANGE**

PAYMENT PROCESS

PSF provides a unique experience for all participants that participate in the PSF 8v8 season. To ensure all participants are equally rewarded all teams MUST have a zero balance one week prior to kickoff classic. Failure to do so will result in the team being removed from the schedule. PSF will invoice the team, not the parent individually. If the team has an open balance the ENTIRE team will be removed from the schedule, NOT the individuals. PSF elects to deal directly with the teams and not the parents, thus this is the team's responsibility. One invoice will be sent to the point of contact for the team. The payment will be accepted electronically (on-line).



“WHERE ATHLETES ARE MADE”

GENERAL KNOWLEDGE

Penalties Summary

Loss of five yards:

- Delay of game
- Encroachment
- False Start
- Illegal formation
- Illegal forward pass
- Illegal forward lateral
- Ineligible receiver down field
- Incidental face mask
- Intentional grounding
- Illegal substitution
- Illegal shift or motion

Loss of ten yards:

- Holding
- Illegal use of hands (hands to the face, block in the back)

Loss of fifteen yards:

- Un-sportsmanlike conduct (by a player, coach, or spectator)
- Intentional or accidental coach interference while on field
- Block below the waist
- Clipping, tripping, chop block
- Grasping an opponent's face mask
- Roughing the passer
- Slapping a blocker's head
- Illegal participation
- Sideline interference
- Illegal hit or block after a fair catch signal

Disqualification:

- Fighting whether it is a player or spectator
- Striking, kicking, or kneeing any player or spectator
- Any contact with a game official
- Two un-sportsmanlike fouls by a player or spectator (Referee may eject a player, coach, and spectator for one unsportsmanlike conduct depending on severity of action)
- Any other act that is unruly, rough, and/or flagrant